

Data Sheet



Article number: 20612230

Description: E+G indexing mechanism
GN 200-52-K16-AS

Measures

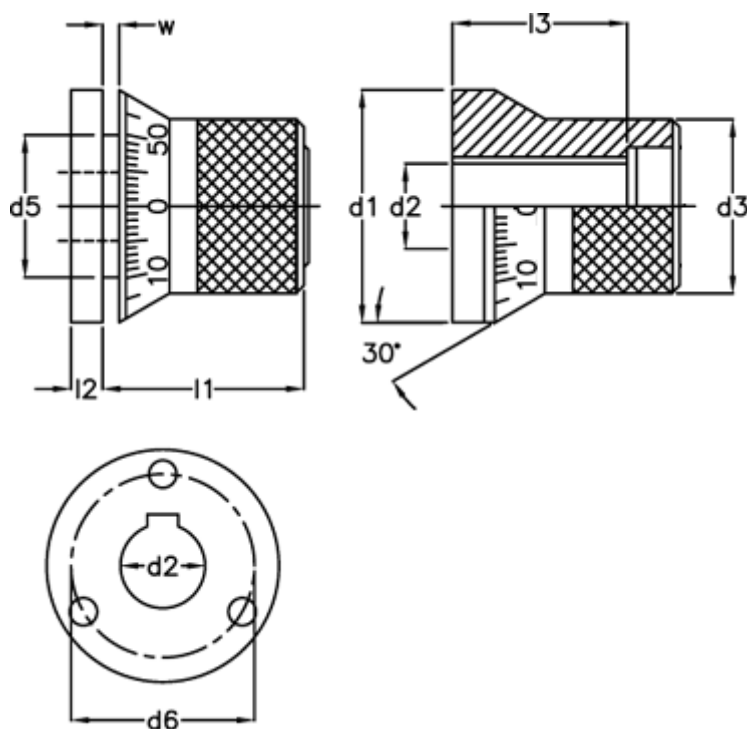

d1 = 52
d2 = K16
d3 = 42
d5 = 31.5
d6 = 41.8
l1 = 37.5
l2 = 6
l3 = 31.5

W = 4